

DAMMANN[®]



Pflanzenschutztechnik
Fahrzeugtechnik
Airporttechnik

DAMMANN Trailed Sprayer

Classic

Profi-Class

Profi-Class Tandem





Classic

- 4400 - 5800 l capacity
- 500 l internal fresh water tank
- 18 - 39 m boom
- 5 - 12 sections
- Large suction and pressure filter - permanent pressure filter flushing controlled via control valve
- ISOBUS control via terminal BASIC, joystick III and ECU III MAXI
- Injector for increasing the suction power during filling
- Piston diaphragm pump 250 l/min or 320 l/min, driven by the power hydraulics of the tractor.
- Single nozzle carrier

Options:

- Tyre pressure control system
- 14 sections
- Centralized lubrication

	Classic	Tyres
Capacity	4400 l	20.8 x 38
	5000 l	520/85 R38
	5800 l	520/85 R42
Fresh water tank	500 l	
Boom width	18 m	
	20 m	
	21 m	
	24 m	
	27 m	
	28 m	
	30 m	
	33 m	
	36 m	
39 m		
Pump capacity	250 l/min - 320 l/min	
Track width	1,80 - 2,25 m	
Speed	40 km/h	



Profi-Class

- 5000 - 7000 l capacity
- 500 l internal fresh water tank
- 24 - 39 m boom
- 7 - 12 sections
- Large suction and pressure filter, with regulated permanent pressure filter flushing, can be pneumatically switched off
- ISOBUS control via terminal BASIC, joystick III and ECU III MAXI
- Injector to increase the suction power at the fill
- Piston diaphragm pump 320 l/min or 500 l/min, driven by the tractor's power hydraulics
- Tandem nozzle carrier

Options:

- Tyre pressure control system
- 14 sections
- Quattro nozzle carrier
- Central lubrication

Profi-Class Tandem

- 8000 - 14000 l capacity
- 500 l internal fresh water tank
- 30 - 42 m boom
- 7 - 12 sections
- Large suction and pressure filter, with regulated permanent pressure filter flushing, can be pneumatically switched off
- ISOBUS control via terminal BASIC, joystick III and ECU III MAXI
- Injector to increase the suction power at the fill
- Piston diaphragm pump 500 l/min, driven by the tractor's power hydraulics
- Tandem nozzle carrier

Options:

- Tyre pressure control system
- 14 sections
- Quattro nozzle carrier
- Central lubrication

	Profi-Class	Profi-Class Tandem	Tyres
Capacity	5000 l	-	520/85 R38 155 A8
	6000 l	-	520/85 R42 162 A8
	7000 l	-	520/85 R46 173 A8
	-	8000 l	520/85 R38
	-	10000 l	520/85 R38
	-	12000 l	520/85 R38 164 B
	-	14000 l	520/85 R38 166 B
Fresh water tank	500 l		
Boom width	24 m	-	
	27 m	-	
	28 m	-	
		30 m	
		33 m	
		36 m	
		39 m	
	-	42 m	
Pump capacity	320 l/min - 500 l/min	500 l/min	
Track width	2,00 - 2,25 m	2,00 - 2,25 m	
Speed	40 km/h	50 km/h	



ISOBUS-System

- Individual adaptation options for almost every function of the crop protection sprayer
- Volume measurement via flow meter and pressure sensor
- Pressure control of the constant-pressure diaphragm body
- Control of hydraulic functions
- Level measurement (EasyControl)
- Circulation control
- Integrated order counter
- Operation via:
 - Joystick
 - S-Box
 - ISOBUS terminal
- Automatic boom control (option)



Overview Terminal

	1	2	3	4
	BASIC Terminal	MC 1	HD 8 pad	HD 12 pad
Standard as of classic	standard	option	option	Option
Screen	5,7"	10,4"	8"	12,1"
Operation by	buttons	buttons	touch	touch
GSM Modem*	-	option	option	option
Connector of cameras	-	option	yes	yes
USB connector	yes	yes	yes	yes
Update with APPS	yes	yes	yes	yes

* SIM card not included

The DAMMANN terminals comply with the ISO 11783 standard and are AEF-certified. Please refer to the AEF database for the current status of certified functionalities*.

ISOBUS-TC — TASK-Controller for ISOBUS Processing

(option for BASIC terminal und *HD 8 pad*)

- Convenient documentation
- Simple planning of applications
- Data exchange to the Farm Management Information System
 - About ISO-XML
 - Shape format
- Imports and exports finished documentation for the Farm Management Information System (FMIS)



1



2



3



4



5

1 BASIC-Terminal

2 MC 1-Terminal

3 HD 12 pad

4 HD 8 pad

5 Joystick

TRACK-Leader Parallel Driving System

(option)

- Exact driving of parallel tracks
 - In A/B, A+, headland or contour mode
- Mark obstacles and save field data such as boundaries
- Interrupted operations can be saved and continued at any time
- On-screen-lightbar
- HEADLAND-Management® included

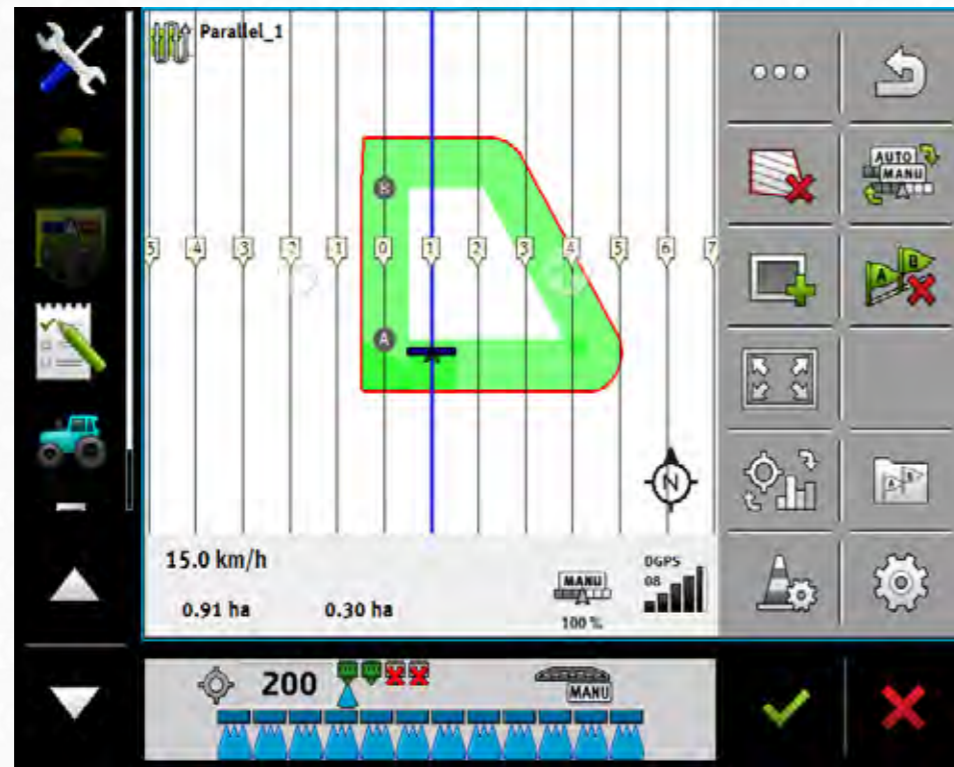

SECTION-Control

(option)

- GPS-controlled switching on and off of boom sections or individual nozzles
- Advantages:
 - Fewer overlaps
 - Work even at night or in poor visibility
 - Savings in resources
- Can also be used for other devices

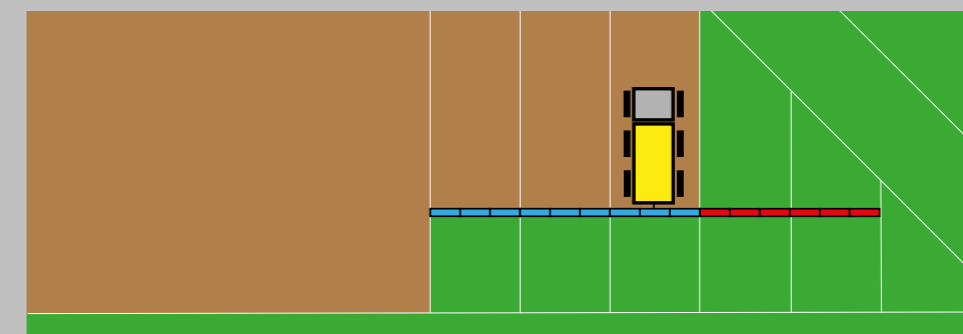



GPS Receiver

(option)

- Correction signals EGNOS, WAAS, GLONASS, GLIDE or RTK
- Deviations between 2 - 25 cm (depending on GPS receiver)



Weather Station

(option)

- Recording by ISOBUS
- Display of data on ISOBUS terminal:
 - Air temperature
 - Wind direction
 - Air pressure
 - Relative humidity
 - Longitudinal inclination
 - Cross slope
 - Apparent and actual wind speed



DAMMANN Fluid Indicator

(option)

Display of pH value and temperature

- Measurement of the pH value and the temperature in the tank sump
- Indication in the display
- The user can influence the pH value of chemical mixture during the induction process

Influence of the pH value on pesticides

- Greater effect of the plant protection product in the case of an ideal pH value
- Reduction of saponification
- Resistances are avoided by optimal pH-value

The water temperature also plays a role

- Better solubility in warm water, especially with salty components in the PSM

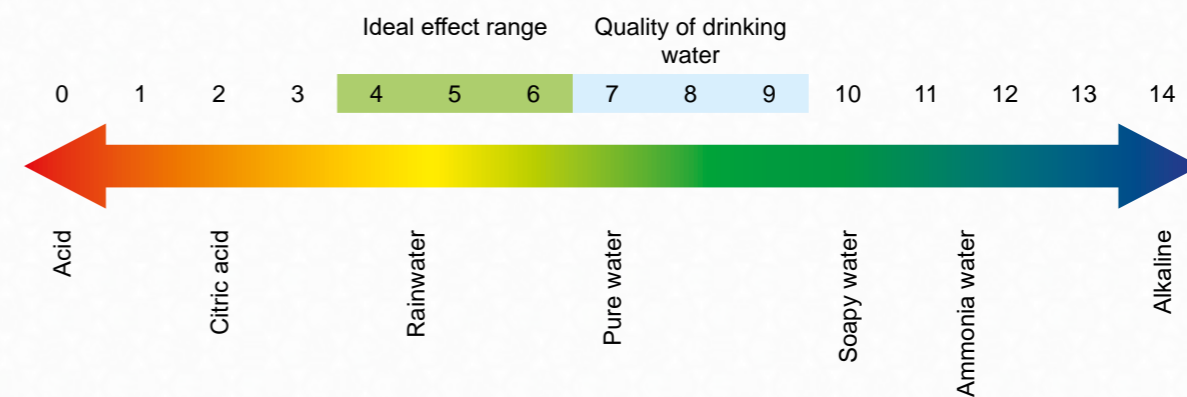







Nozzles and Nozzle Switches

Nozzle Carrier and Nozzle Tube

- Standard electropneumatic tandem nozzle carrier
- 1/2" stainless steel nozzle tube
 - 1" stainless steel nozzle tube (option)
- Pressure circulation flushing
 - Immediate availability of spray liquid at the nozzle carriers
 - Prevents an uneven start of the nozzles (butterfly effect)
- Individual adjustment of 5 - 14 boom sections according to customer requirements (for partial EDS up to 18 boom sections)
- Further nozzle carriers are available as an option:
 - Single nozzle carrier
 - Triple nozzle carrier
 - Quattro nozzle carrier with multifunction switch

Nozzle Control

(option)

	Vario-Select Automatic multifunction circuit
	MultiSelect Management of two nozzle sets in one nozzle line
	EDS (TB-EDS) Single nozzle control
	T-S-D Partial surface-specific nozzle switching for surface treatment according to application chart with different spray rates within one working width
	S-D-S Sensor nozzle control
	C ~ C ~ A® Curves ~ Control ~ Application



1 Single nozzle carrier



2 Triple nozzle carrier



3 Tandem nozzle carrier



4 Quattro nozzle carrier

Vario Select

(option)

- Constant drop size at alternating speed
- Automatic change between nozzles for nozzle carriers with multi-function switching
- Use of several nozzles on the tandem and quattro nozzle carrier
- Nozzle change without work interruption



MultiSelect

(option)

- Management of two nozzle sets per nozzle line
- Up to four nozzles per nozzle set possible
- Quick change from 25 to 50 cm
- Selection and control of the nozzle sets by Vario-Select on the ISOBUS terminal
- Use of single to quattro nozzle holders possible every 25 cm

Innovation

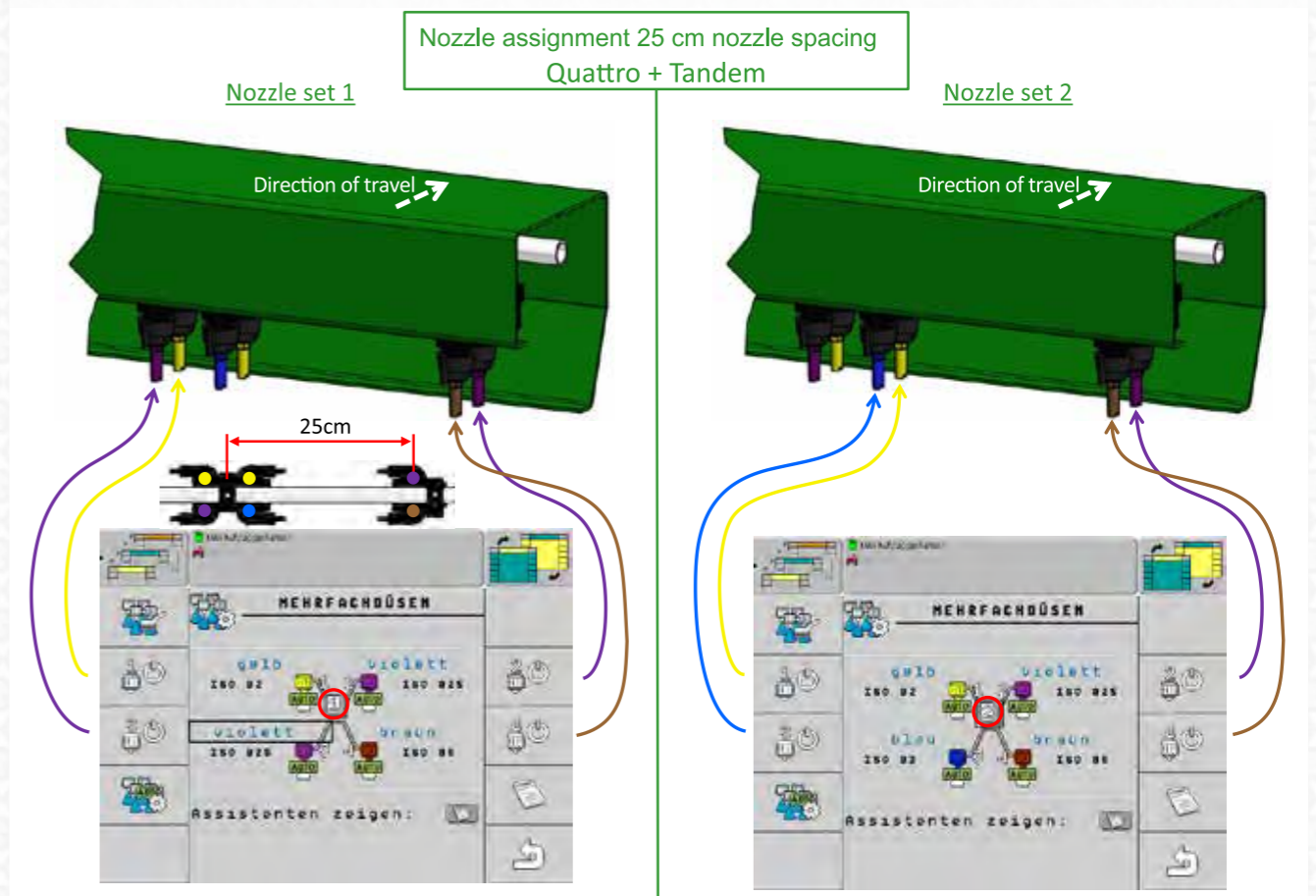

Partial EDS-pro

(option)

- Up to 18 sections can be switched independently of each other via ISOBUS
- Incl. VarioSelect software
- Incl. C~C~A® Curve~Control~Application (recommendation: Quattro nozzle holder)
- More precise SECTION-Control ► thus higher savings potential in the PSM area

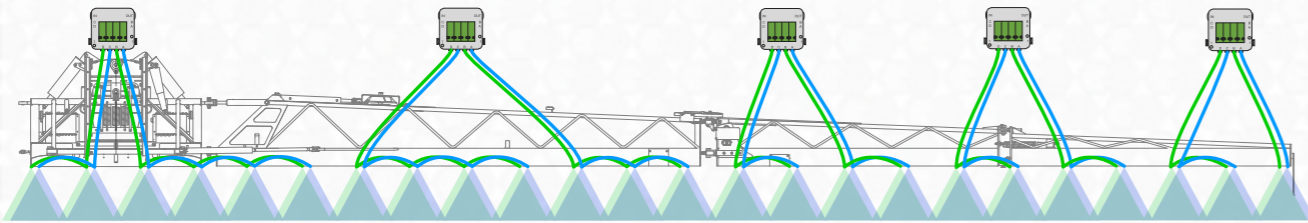

E-D-S — Individual Nozzle Control

(option)

- Savings potential by reducing the total overlap area
 - Less than 1% overlap possible due to GPS-controlled circuitry
 - 10 - 15 % savings in pesticides possible
- User friendly

E-D-S

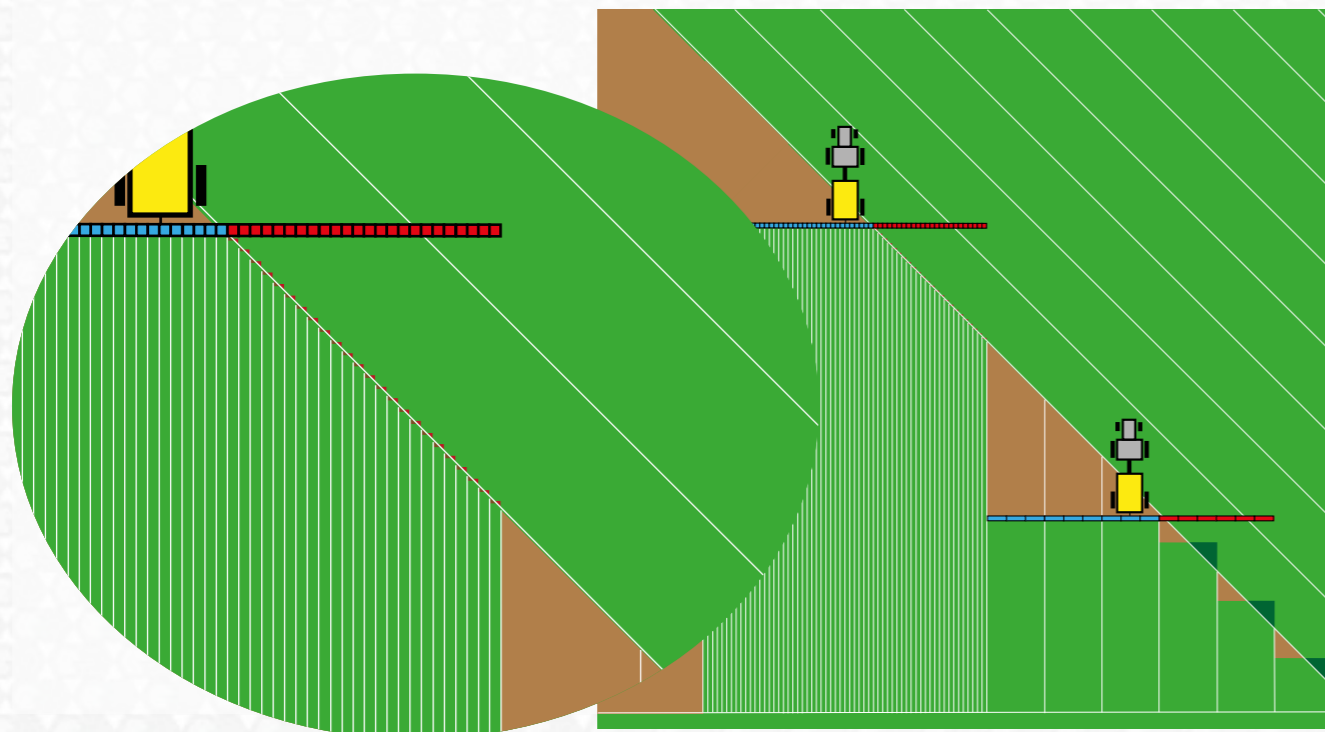

T-S-D — Partial Area Specific Nozzle Switching

(option for TB-EDS or EDS)

- Different application rates for the individual boom sections

T-S-D



S-D-S

S-D-S — Sensor Nozzle Control

(option for TB-EDS or EDS)

- Spray rate after sensor measurement
- 2, 4 or 6 sections with one sensor each
- Data exchange with the external computer unit

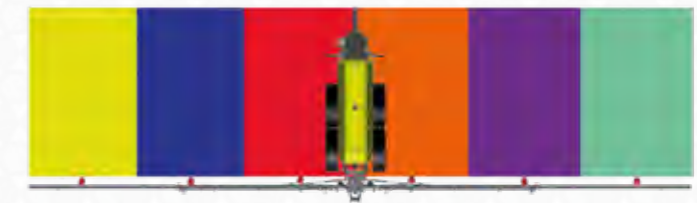

C ~ C ~ A® — Curves ~ Control ~ Application

(option)

- Calculates the different spray rate in curves
- Sensors determine the curve radius

C C A
Curves - Control - Application



Booms

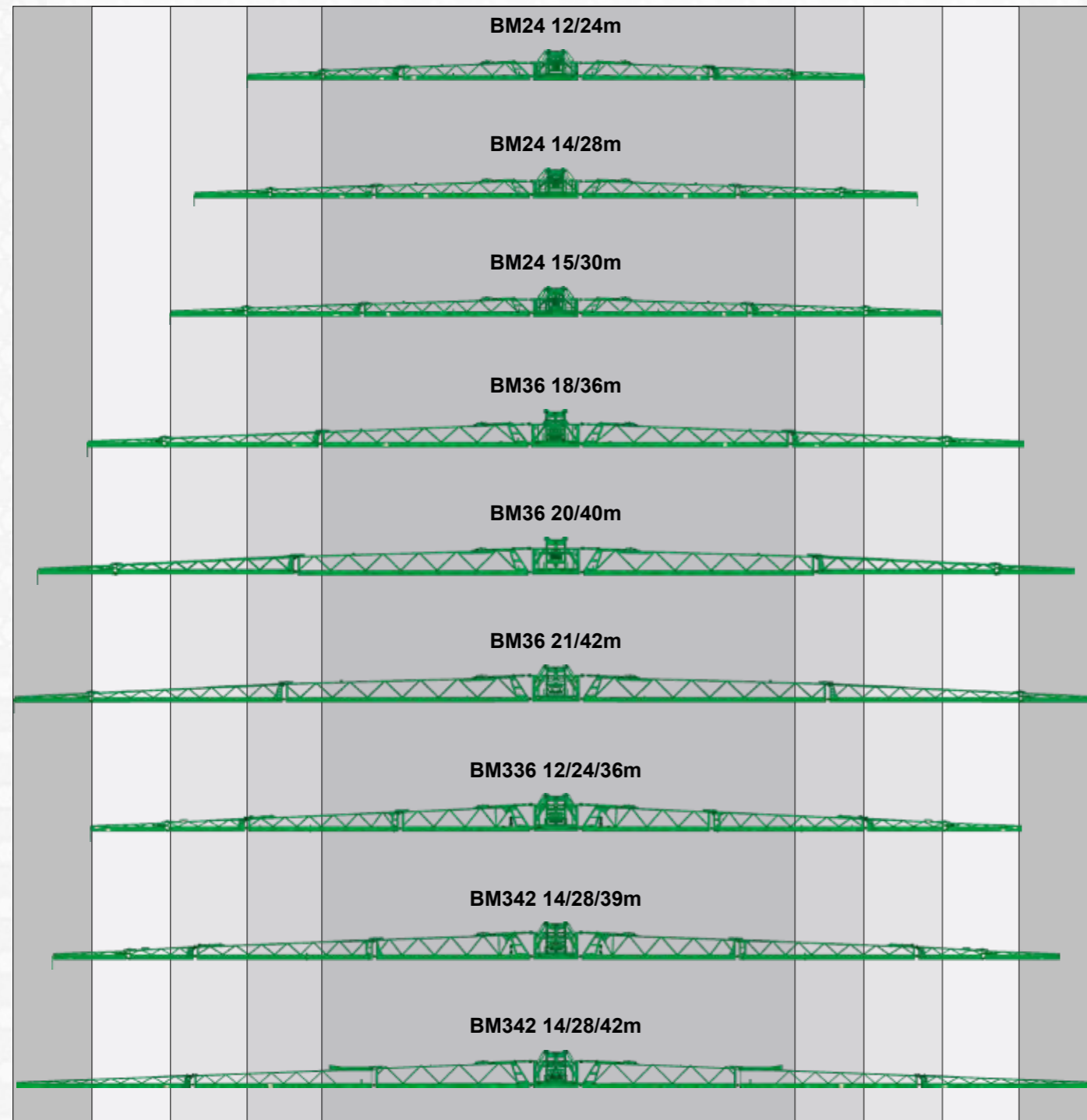

Booms can be shortend in the outer part

G-Booms

- Sturdy sprayer boom with hydraulic folding and special G-shape for protection of the nozzles
- Standard slope control for work on hilly terrain
- Electropneumatic slope compensation via double cylinder
- Outer aluminium booms for weight reduction with collision protection
- Spring-loaded, horizontally and vertically damped boom suspension
- Sturdy lift mast with stepless height adjustment without weight shifting
- Stable pendulum suspension for quiet boom guidance, even in hilly terrain

DCD Distance Control DAMMANN

(option)

- Combines the advantages of hydraulics (speed) and pneumatics (gentle repositioning) in one boom control system
- Monitoring of the optimum boom position by ultrasonic sensors
- Detection and anticipation of gravitational forces in curves
- Quick and easy operation
- Precise boom working height above the crop in the terminal adjustable
- Calibration of the boom control takes place via the terminal
- Possible types of control depending on the equipment of the DCD's
 - Raising/lowering the boom
 - Tilting the boom
 - Angling (optional negativ angling) of the boom
 - Lifting/lowering + tilting the boom
 - Raising/lowering + angling (optional negativ angling) of the boom
- Switching off the height control
 - Manually by the operator
 - Automatic when the maximum permissible excavation height is reached

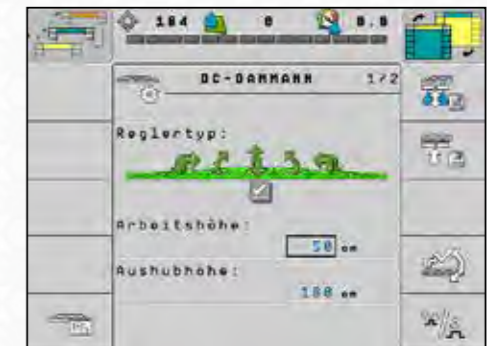

Boom Angling and Negative Angling

(option)

- Perfect extension for boom control
- Angle of advantage in cropped terrain
- Keeps constant distance through sensors to the inventory

Flexible Working Width

(option)

- On different strokes through:
 - Flange plates
 - Folding hinges
 - Hydraulic folding hinges
 - Special folding at the pivot point
- Controllable via the ISOBUS terminal

Fluid Circuit

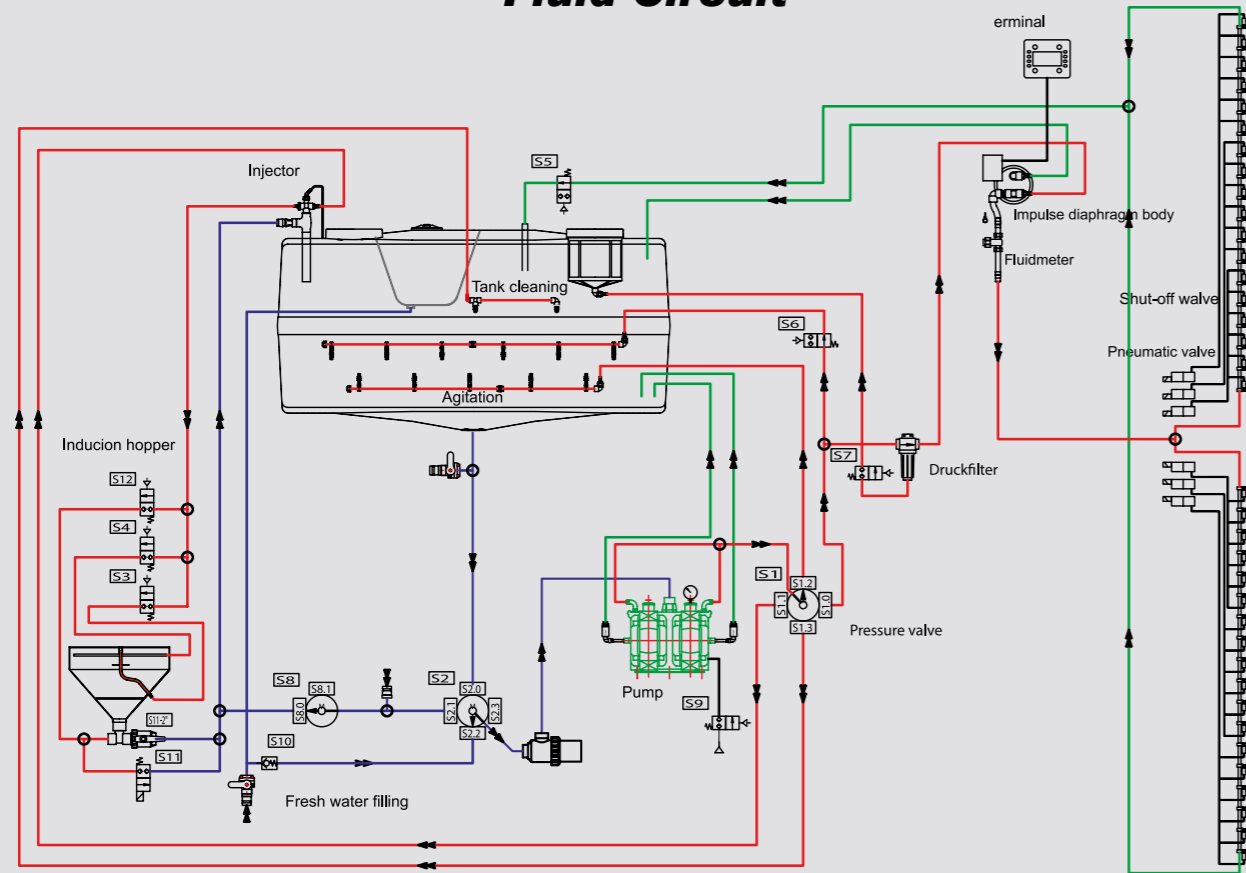

EasyControl

Digitale fill level indicator

- Integrated in the ISOBUS system
- Switching functions of the ISOBUS system on the device
- Work lights, agitator, filter flushing, ...
- CID and RRW are controlled via **EasyControl**
- Series for all Profi-Class devices (option for Classic)

Innovation



Tank

- Proven case shape
- GFK coated
- Easy cleaning due to smooth inner walls
- Baffles for additional safety
- Integrated fresh water tank

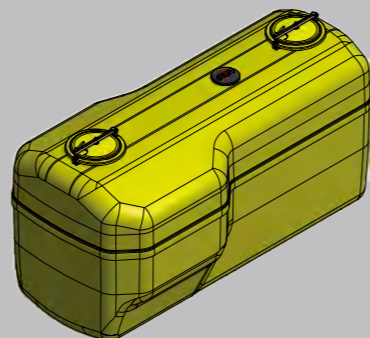

Pump

- Self-priming piston diaphragm pump
- Robust and durable design
- Pump capacity from 320 - 750 l/min depending on equipment and customer requirements



Pneumatic Constant-Pressure Diaphragm Body

- Always ensures constant spraying pressure due to pneumatic counter pressure in the lines, even with open or closed nozzles

Induction Hopper and Injector

- 60 l volume
- Fresh water supply during filling, ergonomic working height
- With ring flushing, which produces a rotating liquid flow. For dilution and lump-free irrigation of plant protection agents
- Jet nozzle - for easy loosening of solid clumps
- Integrated, powerful canister flushing system for crop protection containers
- Pneumatic lifting and lowering of the induction bowl
- Ergonomic and user-friendly working height
- Injector enables the suction of solids from the induction centre into the tank
 - System suction capacity with pump and injector up to 800 l/min
 - Faster filling of the tank

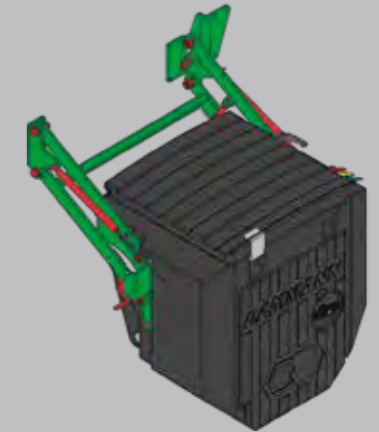

proControl III

(option)

- For recurring filling and cleaning processes
- Automated cleaning modes
- Easy to use
- The functions of **proControl III** can be controlled from the cabin
- Via the ISOBUS terminals
- Remote control of the valves on the machine
- Leave additional functions, such as pump or lighting
- Operate via the terminal on the device
- **proControl III** also cleans the induction hopper during cleaning processes



MFS — Multi-Fluid-System

Two tanks in one sprayer

(option)

- One tank with two parts
- Two spray systems
- One terminal
- One or two nozzle lines
- One induction bowl for both systems

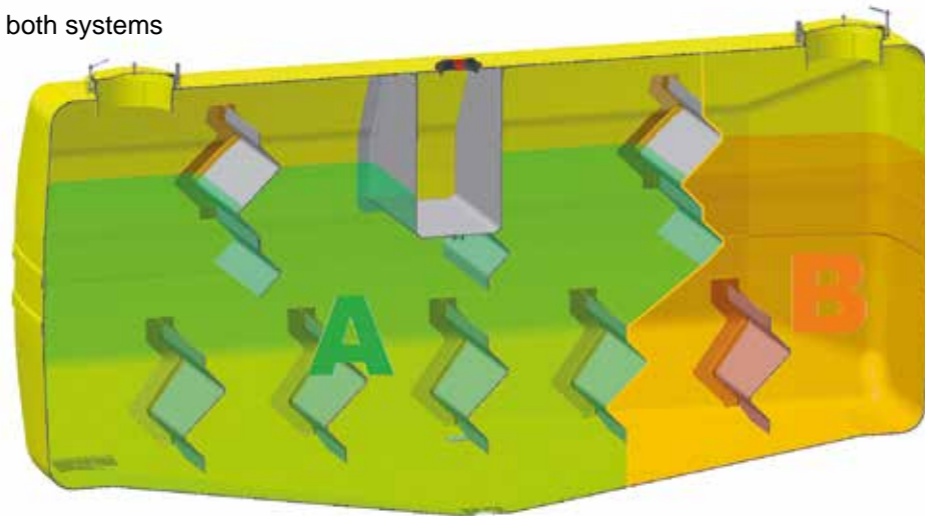

External Filling

(option)

- Filling via 2" or 3" external filling connection with Camlock coupling and shut-off valve
- Filling via hydrant filling connection with C- or B-coupling and non-return valve
- Pneumatic emptying of the external filling hose
- Bypass at the injector for direct external filling

Filling Pump

(option)

- Filling with 900 l/min
- Hydraulically driven

Inside Cleaning



RRW — Rotating Agitator and Cleaning Unit

(option)

- Central mounting in the lower part of the tank
- Special injector nozzles for stirring and cleaning the tank
- The swivel angle is controlled as a function of the filling level
- The driver can start the cleaning program via **EasyControl** in the cab
- Complete tank interior cleaning through 360° rotation of the nozzle shaft
- JKI tested

CID - Continuous Insidecleaning DAMMANN

(option)

- Level sensor-controlled automatic start of CID, interrupts cleaning if the level is too high
- Easy handling and thorough cleaning of the crop protection implement
- High cleaning efficiency with lower fresh water requirement
- High user protection, as the driver can start internal cleaning from the cab or via **EasyControl**
- Easy handling prevents point loads of PSM into surface waters due to improper handling cleaning (environmental protection)
- No premature dilution of the spray liquid due to operating errors
- Sufficient fresh water remains in the fresh water tank for the final interior and exterior cleaning
- JKI tested

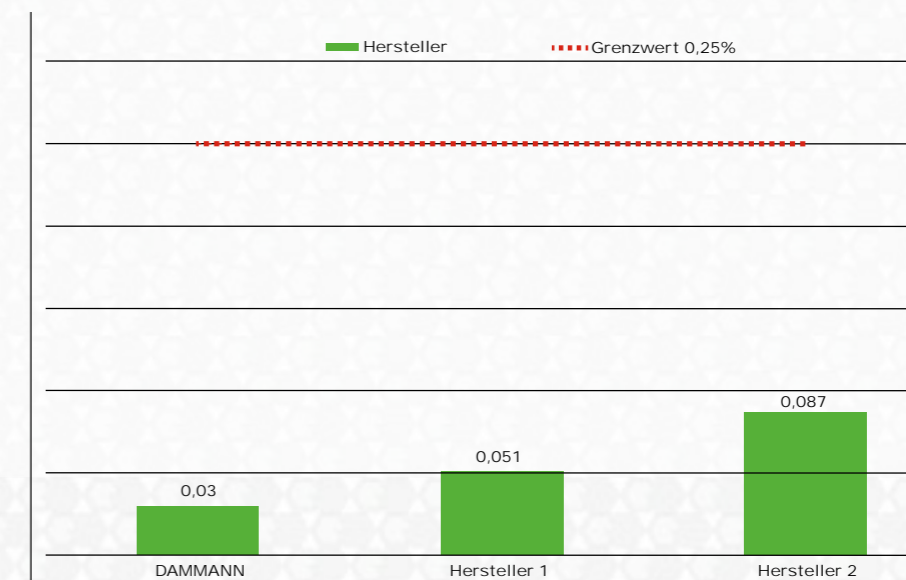



Possible Equipment

Tire Pressure Control System

(option)

- Ideal rolling resistance on the road to save fuel and minimise tyre wear
- Optimum ground pressure in the field
- Control via the ISOBUS terminal
- Optional automatic level-controlled adjustment of the internal tyre pressure by ATC
- Optional additional compressor for fast filling



60 km/h

(option Profi-Class Tandem)

The Profi-Class Tandem is also available with 60 km/h depending on the tyres.



Drawbar

Steering Drawbar

(option)

- True tracking of the trailed sprayer within the
- Tramline
- Increased manoeuvrability
- Minimization of crop damage

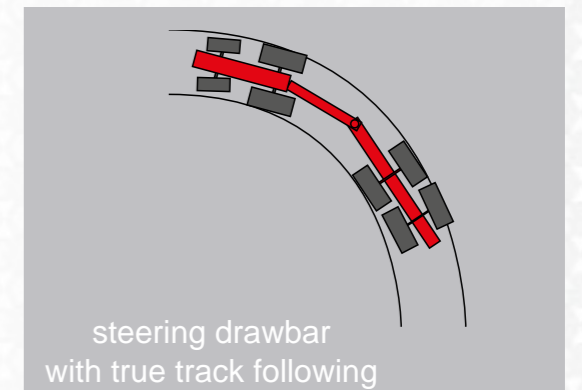

Hydraulic Support Leg

(option)

- Convenient parking

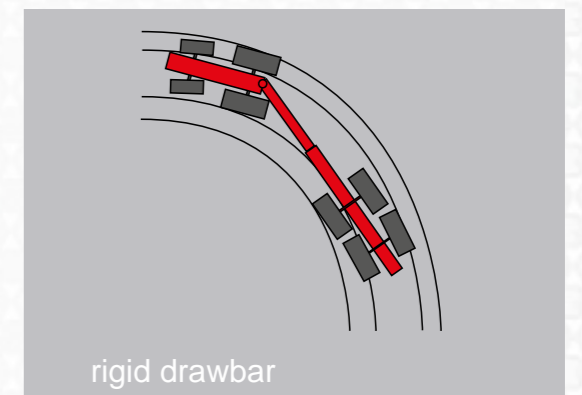



Traction Reinforcement for Profi-Class Tandem

(option)

- Relief of the front axle at low tank capacity
- Better traction
- Easier handling by securing the support load

Rear Axle Steering for Profi-Class Tandem

- Soil and crop protection
- Smaller turning circle
- Reduced tyre wear
- Tractor protection
- Lower maintenance costs

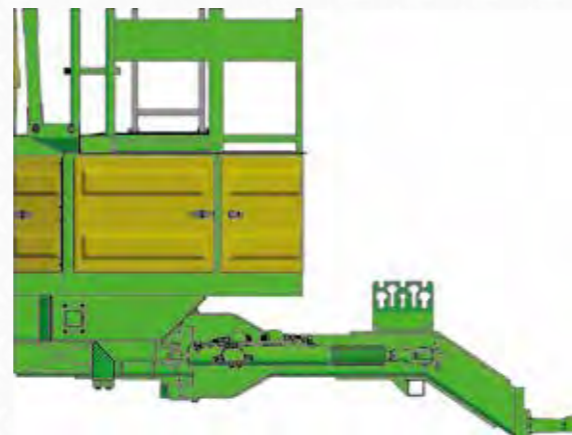

Bottom Hitch

(option, not in combination with D-A-S)

- Fixed and steering drawbars
- K-80 clutch

Maintenance Made Easy with a Central Lubrication Bar

(option)

- Each axle is centrally greased via a lubrication bar
- Easy to reach

Central Lubrication System

(option)

- While the machine is running, the central lubrication system supplies each lubrication point with the necessary grease.
- Absolutely reliable, electronically precisely controlled and precise dosed
- Each bearing and bushing of the axles receives the amount of lubricant it really needs
- No annoying downtimes
- Increases operational readiness and reliability
- Reduces maintenance costs
- Monitoring of flow rate, pressure and grease level
- Automates maintenance
- Operation integrated in the vehicle display
- In addition, the central lubrication system can be fitted to the lifting mast, the boom and all parts of the sprayer





D-A-S — Dual-Air-System

The intelligent solution for the environmentally conscious economist

- Reduced drift, even with low stand heights and on bare soils
- Greater independence from weather influences - treatment time windows are increased
- Higher travel speeds, resulting in increased area performance
- More even active ingredient accumulation in the stock
- Stronger crop penetration, especially for special crops such as vegetables, salads or potatoes
- The powerful air jet turns the active ingredient into the target area even in high populations (e.g. maize)
- Better active ingredient accumulation in the stock leads to less evaporation losses at high temperatures
- Reduction of medium and water application rates
- Devices are entered in the JKI's list of „loss-reducing devices“



without D-A-S



with D-A-S

Lighting and Exterior Cleaning

Best possible and safe working at dusk and at night.

HD-Night LUX

(option)

- Each spraying cone is illuminated by an LED
- Optical control of the function of all activated nozzles
- No overilluminated field
- With the special obstacle finder, the operator can identify obstacles and reacting to them in good time



LED Worklight

(option)

- Mounting of two or four LED worklights
- Positioning of the lighting according to customer requirements

Exterior Cleaning

(option)

DAMMANN offers three options for exterior cleaning:

- Washing brush with hose reel
- Vario spray pipe with hose reel - 15 bar
- High pressure cleaner with 120 bar, hydraulically driven



DAMMANN[®]



**Pflanzenschutztechnik
Fahrzeugtechnik
Airporttechnik**



HERBERT DAMMANN GmbH
Dorfstr. 17
21614 Buxtehude-Hedendorf
Tel.: +49 4163 8163-0
Fax.: +49 4163 8163 71
Web: www.dammann-technik.de
Mail: info@dammann-technik.de